

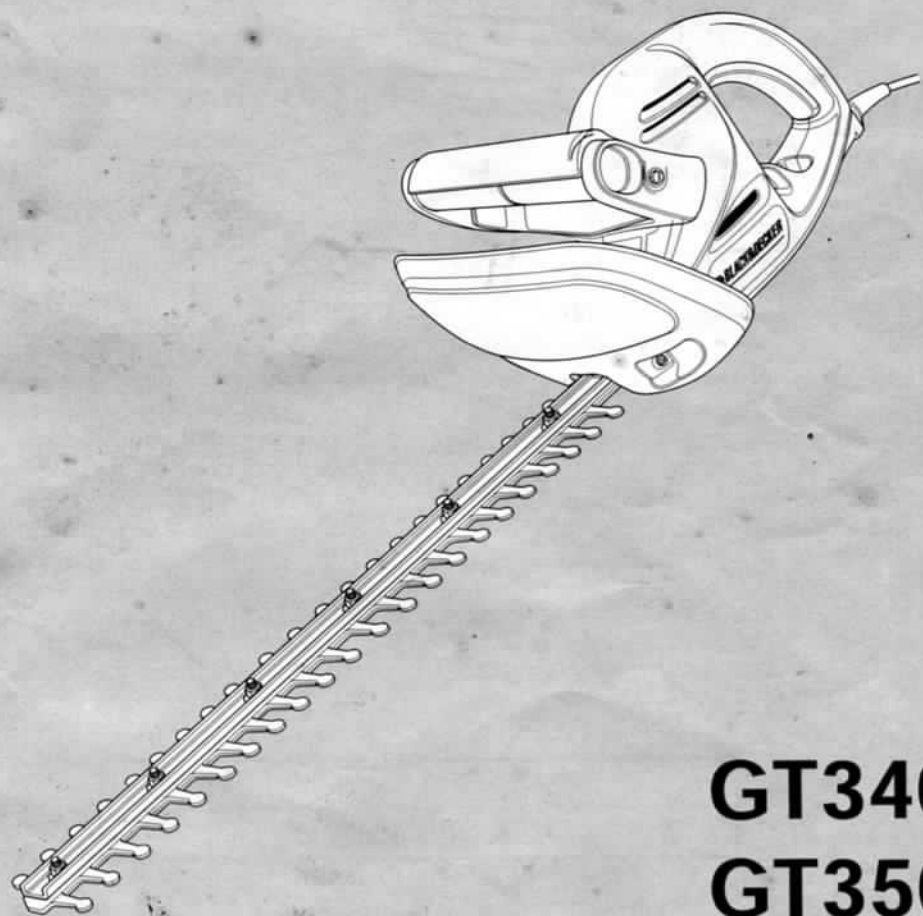

**BLACK &
DECKER®**



GT340

GT350

GT360

GT460 SXC

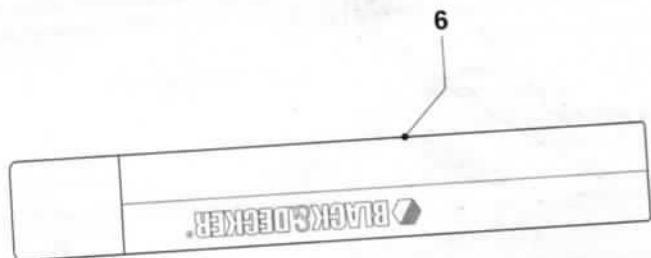
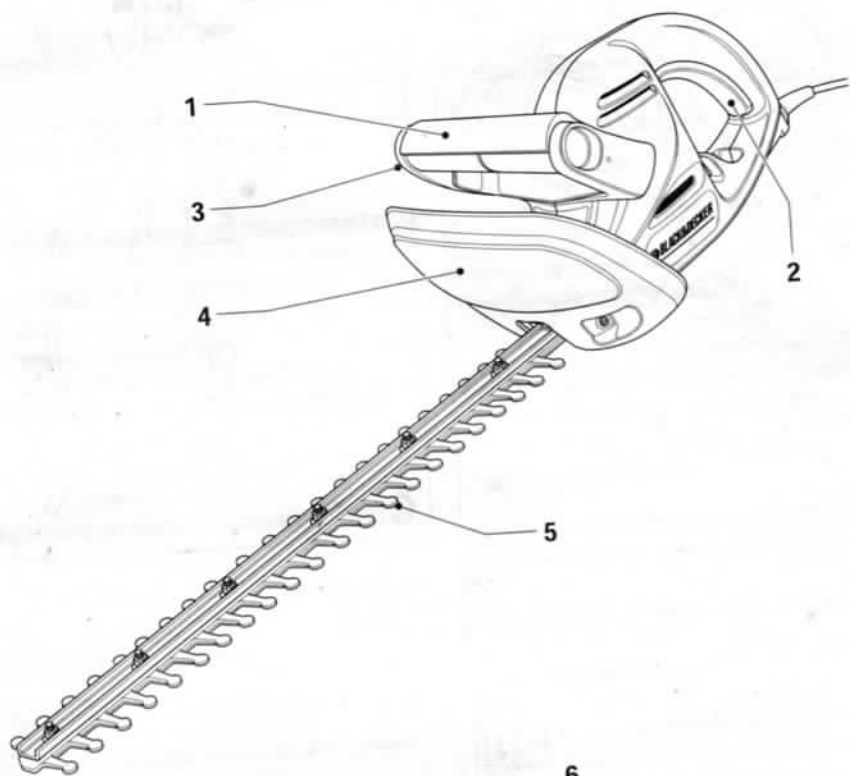

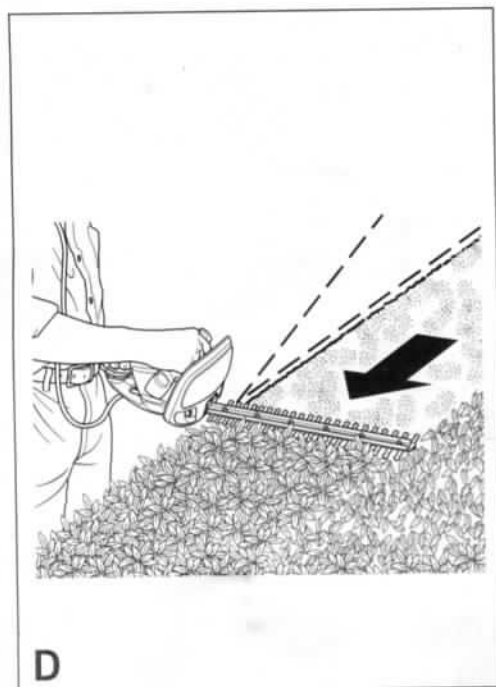
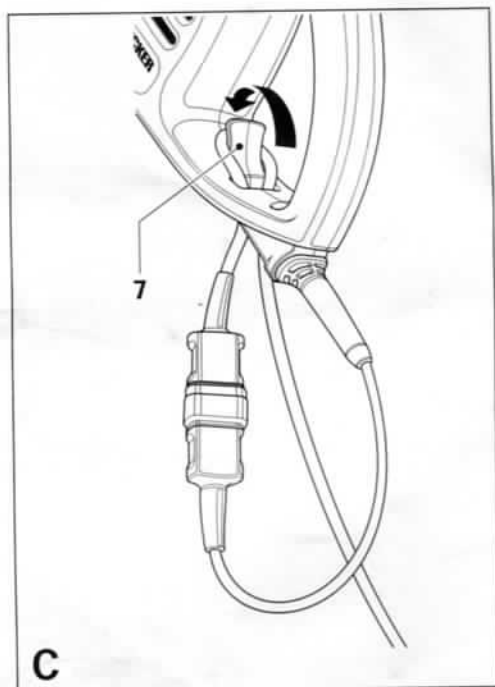
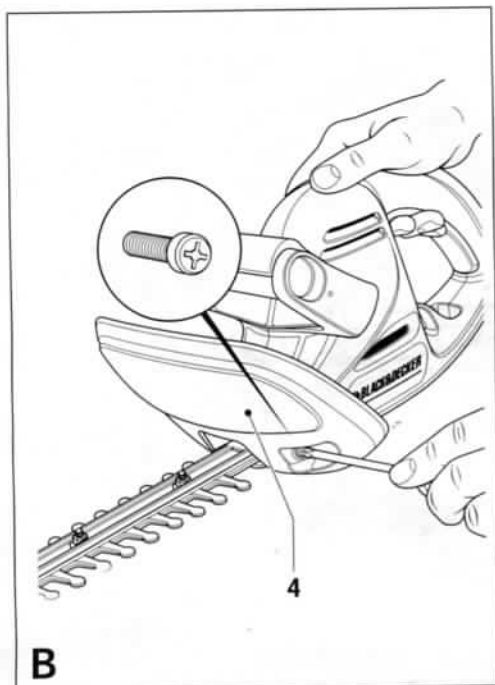

HEDGETRIMMER

GT340/GT350/GT360/GT460SXC

CONGRATULATIONS!

You have chosen a Black & Decker tool. Our aim is to provide quality tools at an affordable price. We hope that you will enjoy using this tool for many years.

EC DECLARATION OF CONFORMITY



GT340/GT350/GT360/GT460SXC
Black & Decker declares that these products conform to:
98/37/EC, 89/336/EEC, 73/23/EEC,
BS 2769 (EN 50144 not including 23.5),
EN 55014, EN 61000, 2000/14/EC,
Hedge trimmer ≤ 400 W, Annex V

Level of sound pressure, measured according to EN 50144:

L_{pA} (sound pressure)	dB(A)	83
L_{WA} (acoustic power)	dB(A)	96
L_{WA} (guaranteed)	dB(A)	99



Always wear ear protection if the sound pressure exceeds 85 dB(A).

Hand/arm weighted vibration value according to EN 50144:

< 2.5 m/s²

Brian Cooke

Director of Engineering
Spennymoor, County Durham DL16 6JG,
United Kingdom
3-10-2001

INTENDED USE

Your Black & Decker hedgetrimmer GT340/GT350/GT360/GT460SXC has been designed for trimming hedges, shrubs and brambles. This tool is intended for consumer use only.

SAFETY INSTRUCTIONS

Warning symbols

The following symbols are used in this manual:



Denotes risk of personal injury, loss of life or damage to the tool in case of non-observance of the instructions in this manual.



Denotes risk of electric shock.



Read the manual prior to operation.

Know your tool



- **Warning!** When using mains-powered tools, basic safety precautions, including the following, should always be followed to reduce the risk of fire, electric shock, personal injury and material damage.
 - Read all of this manual carefully before operating the tool.
 - Before operating the tool, make sure that you know how to switch the tool off in an emergency.
 - Retain this manual for future reference.

General

1. Consider work area environment

Do not expose the tool to rain. Do not use the tool in damp or wet conditions. Keep the work area well lit. Do not use the tool where there is a risk of causing fire or explosion, i.e. in the presence of flammable liquids and gases. Keep the work area free from debris and obstacles.

2. Keep children away

Do not allow children, visitors or animals to come near the work area or to touch the tool or mains cable.

3. Dress properly

Do not wear loose clothing or jewellery, as these can be caught in moving parts. Preferably wear rubber gloves and non-slip footwear when working outdoors. Wear protective hair covering to keep long hair out of the way.

4. Personal protection

Always use safety glasses. Use a face or dust mask whenever the operations may produce dust or flying particles. Wear ear protection whenever the sound level seems uncomfortable.

5. Guard against electric shock

Prevent body contact with earthed or grounded surfaces (e.g. metal railings, lamp-posts etc.). Electric safety can be further improved by using a high-sensitivity (30 mA/30 mS) residual current device (RCD).

6. Do not overreach

Keep proper footing and balance at all times.

7. Stay alert

Watch what you are doing. Use common sense. Do not operate the tool when you are tired.

8. Secure workpiece

Where appropriate, use clamps or a vice to hold the workpiece. It is safer and it frees both hands to operate the tool.

9. Remove keys and adjusting wrenches

Always check that keys and adjusting wrenches are removed from the tool before operating the tool.

10. Extension cables

Before use, inspect the extension cable and replace if damaged. Only use extension cables intended for outdoor use.

11. Use appropriate tool

The intended use is described in this instruction manual. Do not force small tools or attachments to do the job of a heavy-duty tool. The tool will do the job better and safer at the rate for which it was intended. Do not force the tool.

Warning! The use of any accessory or attachment or performance of any operation with this tool other than those recommended in this instruction manual may present a risk of personal injury.

12. Check for damaged parts

Before use, carefully check the tool and mains cable for damage. Check for misalignment and seizure of moving parts, breakage of parts, damage to guards and switches and any other conditions that may affect its operation. Ensure that the tool will operate properly and perform its intended function. Do not use the tool if any part is damaged or defective. Do not use the tool if the switch does not turn it on and off. Have any damaged or defective parts repaired or replaced by an authorised repair agent. Never attempt any repairs yourself. If the supply cord is damaged, it must be replaced by an authorised repair agent in order to avoid a hazard.

13. Unplug the tool

Unplug the tool when it is not in use, before changing any parts of the tool, accessories or attachments and before servicing.

14. Avoid unintentional starting

Do not carry the tool with a finger on the on/off switch. Be sure that the tool is switched off when plugging in.

15. Do not abuse cord

Never carry the tool by its cord or pull it to disconnect from the socket. Keep the cord away from heat, oil and sharp edges.

16. Store idle tools

When not in use, tools should be stored in a dry, locked up or high place, out of reach of children.

17. Maintain tools with care

Keep cutting tools sharp and clean for better and safer performance. Follow the instructions for maintenance and changing accessories. Keep handles and switches dry, clean and free from oil and grease.

18. Repairs

This tool complies with relevant safety requirements. Repairs should only be carried out by qualified persons using original spare parts; otherwise this may result in considerable danger to the user.

Additional safety instructions for hedgetrimmers



Wear safety glasses or goggles when operating this tool.



Wear gloves when operating this tool.



Wear ear protection when operating this tool.



Immediately disconnect the cable from the mains if it is damaged or cut.



Do not expose the tool to rain or high humidity.

- Keep the cable away from the blades while using this tool.
- If you have not used a hedgetrimmer before, preferably seek practical instruction by an experienced user in addition to studying this manual.
- Never touch the blades while the tool is running.
- Never attempt to force the blades to come to a standstill.
- Do not put the tool down until the blades have come to a complete standstill.
- Regularly check the blades for damage and wear. Do not use the tool when the blades are worn or damaged.
- Take care to avoid hard objects (e.g. metal wire, railings) when trimming. Should you accidentally hit any such object, immediately switch the tool off and check for any damage.
- Should the tool start to vibrate abnormally, immediately switch it off and check for any damage.
- If the tool stalls, immediately switch it off. Unplug the tool before attempting to remove any obstructions.

- After use, place the blade sheath supplied over the blades. Store the tool, making sure that the blade is not exposed.
- Always ensure that all guards are fitted when using the tool. Never attempt to use an incomplete tool or a tool with unauthorised modifications.
- Never allow children to use the tool.

Additional safety instructions for Australia and New Zealand

- This appliance is not intended for use by young or infirm persons without supervision. Children must be supervised to ensure they do not play with the appliance.
- If the supply cord is damaged, it must be replaced by the manufacturer or an authorised Black & Decker Service Centre in order to avoid a hazard.

ELECTRICAL SAFETY

The electric motor has been designed for one voltage only. Always check that the power supply corresponds to the voltage on the rating plate.



This tool is double insulated; therefore no earth wire is required.

Mains plug replacement (U.K. & Ireland only)

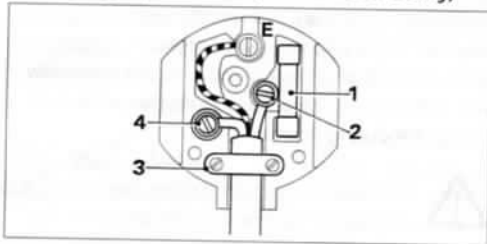

- Should your mains plug need replacing and you are competent to do this, proceed as instructed below. If you are in doubt, contact an authorised repair agent or a qualified electrician.
- Disconnect the plug from the supply and remove the fuse from the plug.
- Cut off the plug and dispose of it safely; a plug with bared copper conductors is dangerous if engaged in a live socket outlet.

- Only fit 13 Amperes BS1363A approved plugs fitted with the correctly rated fuse (1).
- The cable wire colours, or a letter, will be marked at the connection points of most good quality plugs. Attach the wires to their respective points in the plug (see above). Brown is for Live (L) (2), blue is for Neutral (N) (4).
- Before replacing the top cover of the mains plug ensure that the cable restraint (3) is holding the outer sheath of the cable firmly and that the leads are correctly fixed at the terminal screws.
- If the plug has a fuse cover, make sure that the fuse cover is fitted. Do not use the plug if the fuse cover is missing or damaged.



Never use a light socket.

Using an extension cable

Always use an approved extension cable suitable for the power input of this tool (see technical data). The extension cable must be suitable for outdoor use and marked accordingly. When using a cable reel, always unwind the cable completely.

Cable connection system

Black & Decker continually makes every effort to achieve the highest standards in performance, quality and reliability. We recommend the use of a new outdoor cable connection system, which gives additional protection against the possibility of water or moisture entering into the cable connector during normal use.



The new connection system does not release the operator of the tool from the safety precautions and safe working practices given in the manual. Particular attention is drawn to the fact that this connection system is 'weather resistant', but not suitable for immersion, submersion or being subjected to water jets. Take care to prevent the cable from lying in or trailing through pools of water or from splashing with hose pipes.

- The following items are available:
- A6615 20 m cable, socket, 13 Amp plug
 - A6616 20 m cable, socket, 13 Amp plug and Cable Tidy frame
 - A6617 30 m cable, socket, 13 Amp plug and Cable Tidy frame
 - A6613 40 m cable, socket, 13 Amp plug and Cable Tidy reel

Existing cable systems

Your tool either comes with a cable attached (the cat. no. ends with a C) or with a male connector built into the tool. If you already own an outdoor cable system with the old female connector shown below, we recommend that you replace this connector with the new female connector, which is available from most major DIY outlets and from Black & Decker service centres (cat. no. A6624S).



old female connector



new female connector

Follow the instructions supplied with the connector. If in doubt, consult a qualified electrician.

Existing outdoor tools

To connect existing Black & Decker outdoor tools to the new system, you will need an adaptor (see below), which is available as an accessory from most major DIY outlets and from Black & Decker service centres (cat. no. A6623S).

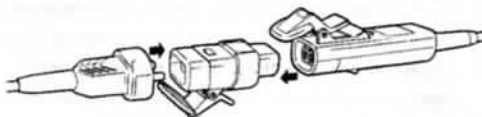

This adaptor is only suitable for products rated up to 500 W. It is not recommended for use with hover mowers, rotary mowers with grass collection, chainsaws, shredders and blower vacs. Please contact your local service centre if you need further advice.

Making your own extension cable

When making your own extension cable, fit a 13 Amp plug to one end of the cable (see "Mains plug replacement") and a female connector to the other end. For wiring instructions, see those supplied with the female connector.

A male connector (see below) is already attached to the power supply cable on your tool. It is non-rewireable and should not be removed. If the connector is damaged and needs replacement, take the tool to a Black & Decker service centre.



female connector



male connector

Never wire an extension cable with anything other than the female connector supplied and a 13 Amp BS1363A approved plug with the recommended fuse. Never wire a male connector to the extension cable. Never wire an extension cable with a plug of any kind at each end of the cable. This is extremely dangerous and results in the pins being live, which may cause a fatal electric shock.

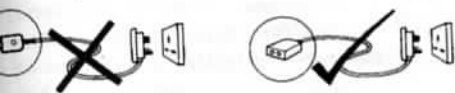

CARTON CONTENTS

The carton contains:

- Hedgetrimmer
- Blade sheath
- Guard
- Screws
- Instruction manual

- Carefully unpack all parts.
- Please note that additional items may be found in the carton, depending on the letter suffix following the catalogue number of your tool.

OVERVIEW (fig. A)

- Front handle switch
- Trigger switch

- Front handle
- Guard
- Blade
- Blade sheath

ASSEMBLY



Before assembly, make sure that the tool is switched off and unplugged.

Fit the blade sheath over the blades.

You will need a number 2 Posidrive screwdriver for assembly.

Fitting the guard (fig. B)

- Place the guard (4) onto the tool as shown.
- Secure the guard using the two screws supplied.



Never use the tool without the guard.

Connecting the tool to the mains (fig. C)

Unless the tool is fitted with a mains cable, you will need to connect an extension cable to the power inlet.

- Connect the female socket of a suitable extension cable to the power inlet.
- Loop the extension cable through the cable restraint (7) as shown to prevent it from becoming detached during use.
- Insert the mains plug into a mains outlet.



The extension cable must be suitable for outdoor use.

USE



Let the tool work at its own pace. Do not overload.

- Carefully guide the cable in order to avoid accidentally cutting it. A good way to control the cable is by putting it over your shoulder.

Switching on and off (fig. A)

For your safety, this tool is equipped with a double switching system. This system prevents starting the tool inadvertently and will only allow operation while holding the tool with both hands.

Switching on

- Squeeze both the front handle switch (1) and the trigger switch (2).

Switching off

- Release the front handle switch (1) or the trigger switch (2).



Never attempt to lock a switch in the on position.

Hints for optimum use

- Slightly tilt the tool (up to 15° relative to the line of cut) so that the blade tips point slightly towards the hedge (fig. D). This will cause the blades to cut more effectively.
- Start by trimming the top of the hedge. Hold the tool at the desired angle and move it steadily along the line of cut. The double-sided blade allows you to cut in either direction.
- In order to obtain a very straight cut, stretch a piece of string along the length of the hedge at the desired height. Use the string as a guideline, cutting just above it.
- In order to obtain flat sides, cut upwards with the growth. Younger stems move outwards when the blade cuts downwards, causing shallow patches in the hedge.
- Take care to avoid any foreign objects. Especially avoid hard objects such as metal wire and railings, as these could damage the blades.
- Regularly oil the blades.

Guidelines for trimming (UK & Ireland)

- Trim hedges and shrubs with seasonal leaves (new leaves every year) in June and October.
- Trim evergreens in April and August.
- Trim conifers and other fast growing shrubs every six weeks from May until October.

Guidelines for trimming (Australia & New Zealand)

- Trim hedges and shrubs with seasonal leaves (new leaves every year) in December and March.
- Trim evergreens in September and February.
- Trim conifers and other fast growing shrubs every six weeks from October until March.

MAINTENANCE

Your Black & Decker tool has been designed to operate over a long period of time with a minimum of maintenance. Continuous satisfactory operation depends upon proper tool care and regular cleaning.



Before performing any maintenance, switch off and unplug the tool.

- After use, carefully clean the blades. After cleaning, apply a film of light machine oil to prevent the blades from rusting.
- Regularly clean the ventilation slots in your tool using a soft brush or dry cloth.
- Regularly clean the motor housing using a damp cloth. Do not use any abrasive or solvent-based cleaner.

PROTECTING THE ENVIRONMENT



Black & Decker provides a facility for recycling Black & Decker products once they have reached the end of their working life. This service is provided free of charge. To take advantage of this service please return your product to any authorised repair agent who will collect them on our behalf.

You can check the location of your nearest authorised repair agent by contacting your local Black & Decker office at the address indicated in this manual. Alternatively, a list of authorised Black & Decker repair agents and full details of our after-sales service and contacts are available on the Internet at: www.2helpU.com.

Technical data

		GT340	GT350
Voltage	V _{AC}	230	220
(Australia & New Zealand)	V _{AC}	240	240
Power input	W	300	400
Blade strokes (no load)	min ⁻¹	1,800	1,800
Blade length	cm	40	51
Blade gap	mm	16	16
Blade brake time	s	< 0.5	< 0.5
Weight	kg	2.3	2.5

		GT360	GT460SXC
Voltage	V _{AC}	230	230
(Australia & New Zealand)	V _{AC}	240	240
Power input	W	400	400
Blade strokes (no load)	min ⁻¹	1,800	1,800
Blade length	cm	63	63
Blade gap	mm	16	16
Blade brake time	s	< 0.5	< 0.5
Weight	kg	2.7	2.7

GUARANTEE

Black & Decker is confident of the quality of its products and offers an outstanding guarantee. This guarantee statement is in addition to and in no way prejudices your statutory rights.

The guarantee is valid within the territories of the Member States of the European Union and the European Free Trade Area.

If a Black & Decker product becomes defective due to faulty materials, workmanship or lack of conformity, within 24 months from the date of purchase, Black & Decker guarantees to replace defective parts, repair products subjected to fair wear and tear or replace such products to ensure minimum inconvenience to the customer unless:

- The product has been used for trade, professional or hire purposes;
- The product has been subjected to misuse or neglect;
- The product has sustained damage through foreign objects, substances or accidents;
- Repairs have been attempted by others than authorised repair agents or Black & Decker service staff.

To claim on the guarantee, you will need to submit proof of purchase to the seller or an authorised repair agent. You can check the location of your nearest authorised repair agent by contacting your local Black & Decker office at the address indicated in this manual. Alternatively, a list of authorised Black & Decker repair agents and full details of our after-sales service and contacts are available on the Internet at: www.2helpU.com.

OTHER OUTDOOR TOOLS

Black & Decker has a full range of outdoor power tools that make life in the garden easy. If you would like further information on the following products, please contact our Service and Information Centre (see the address page towards the end of this manual) or your local Black & Decker retailer.

String trimmers
Chainsaws
Cordless shear
Hedge trimmers
Lawnmowers
Lawnrakers
Leafbusters
Shredders

Not all products are available in all countries.

